



Strap Ends x 2 (This is a fixed leng



Bottom Piece





th strap from 2 pieces. Adjust length during assembly as needed)

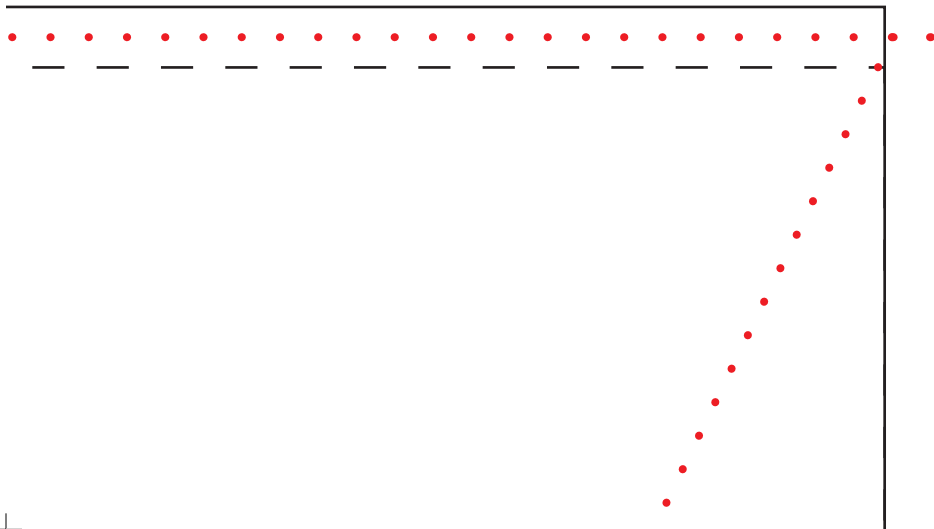

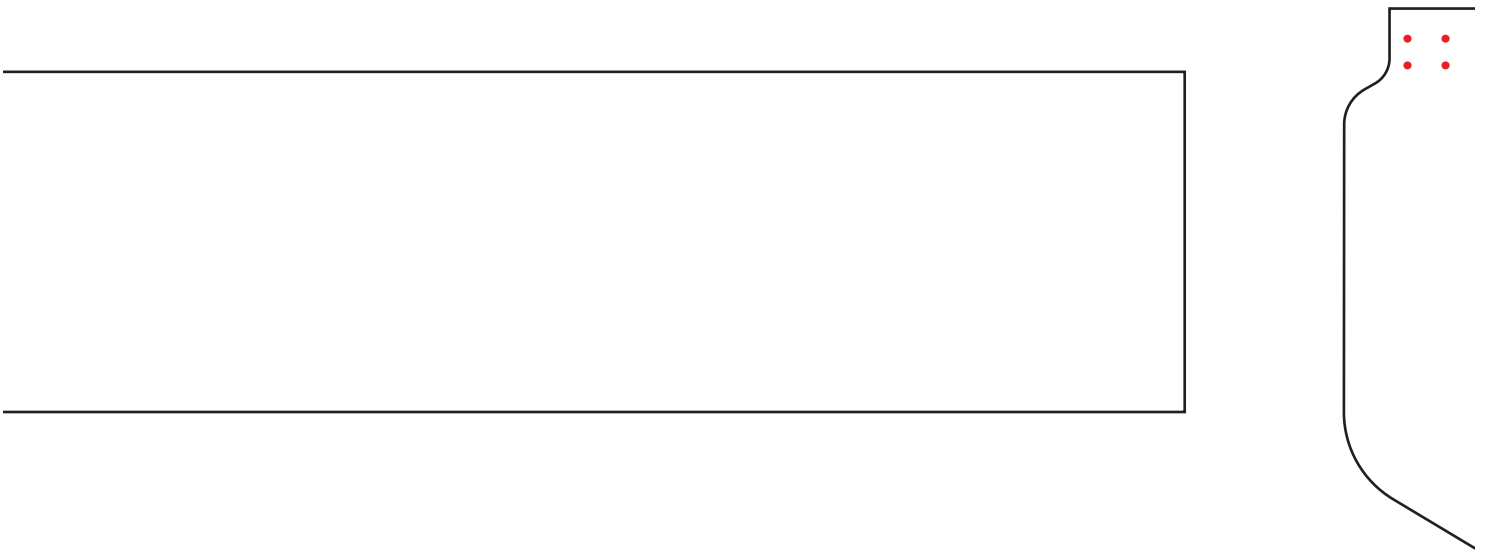

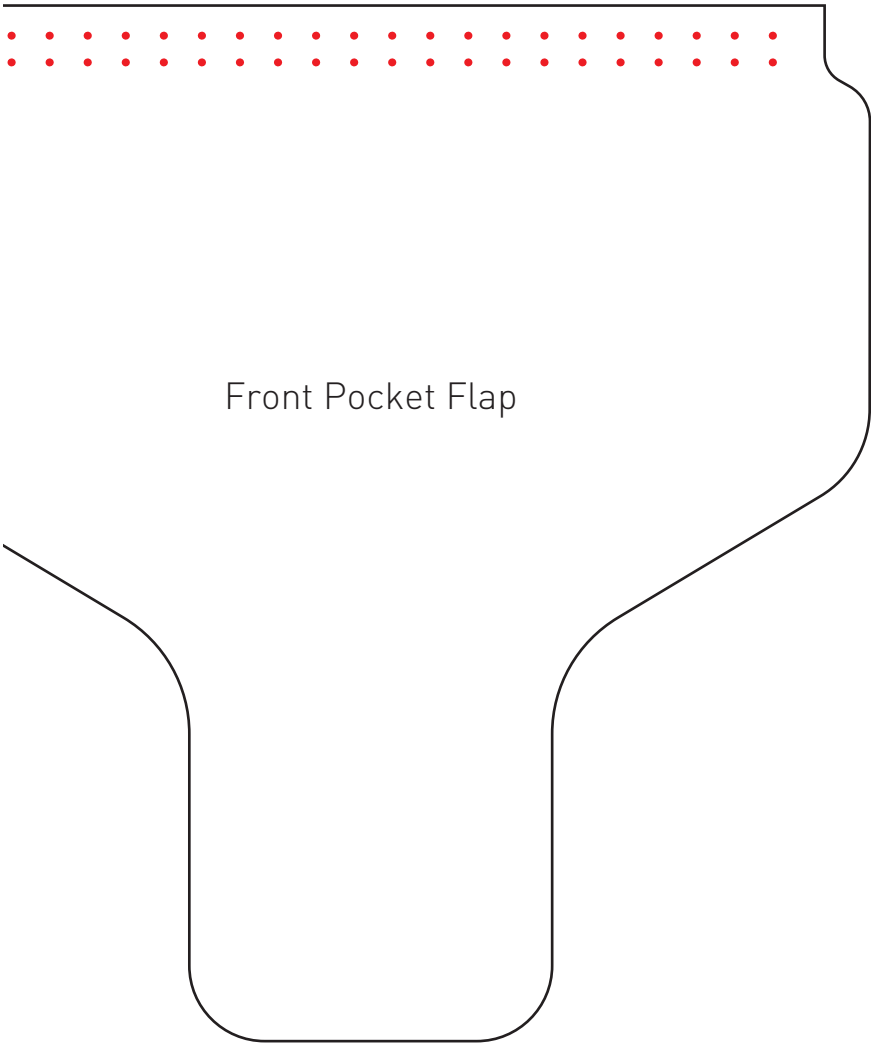

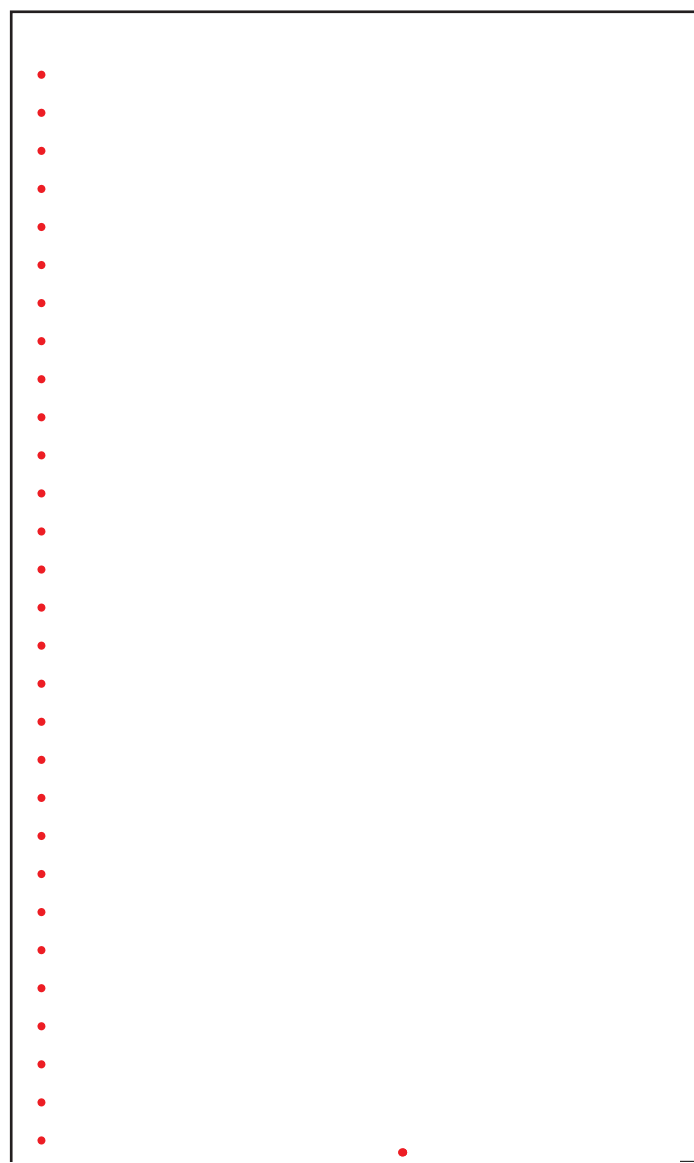
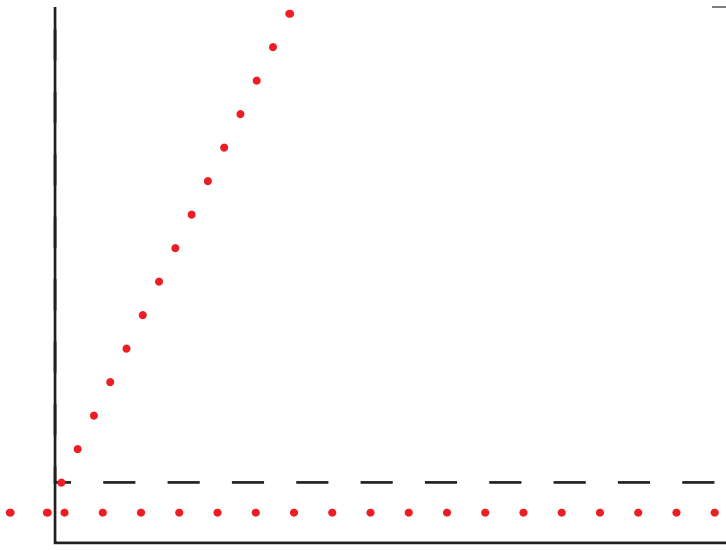



Bottom view

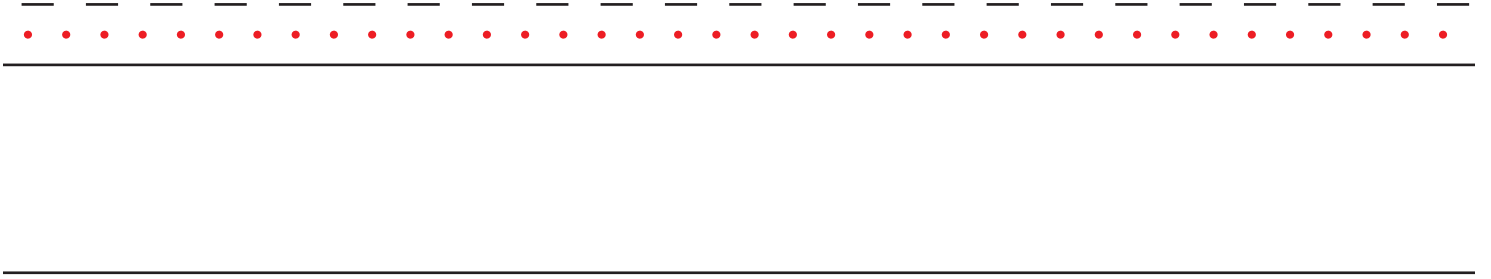

Front



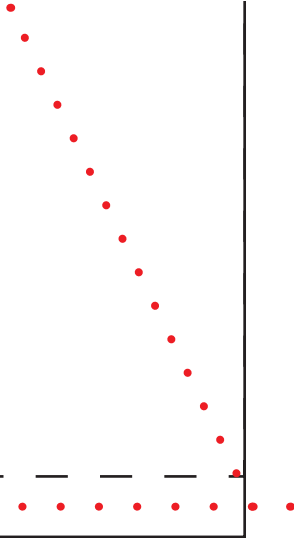

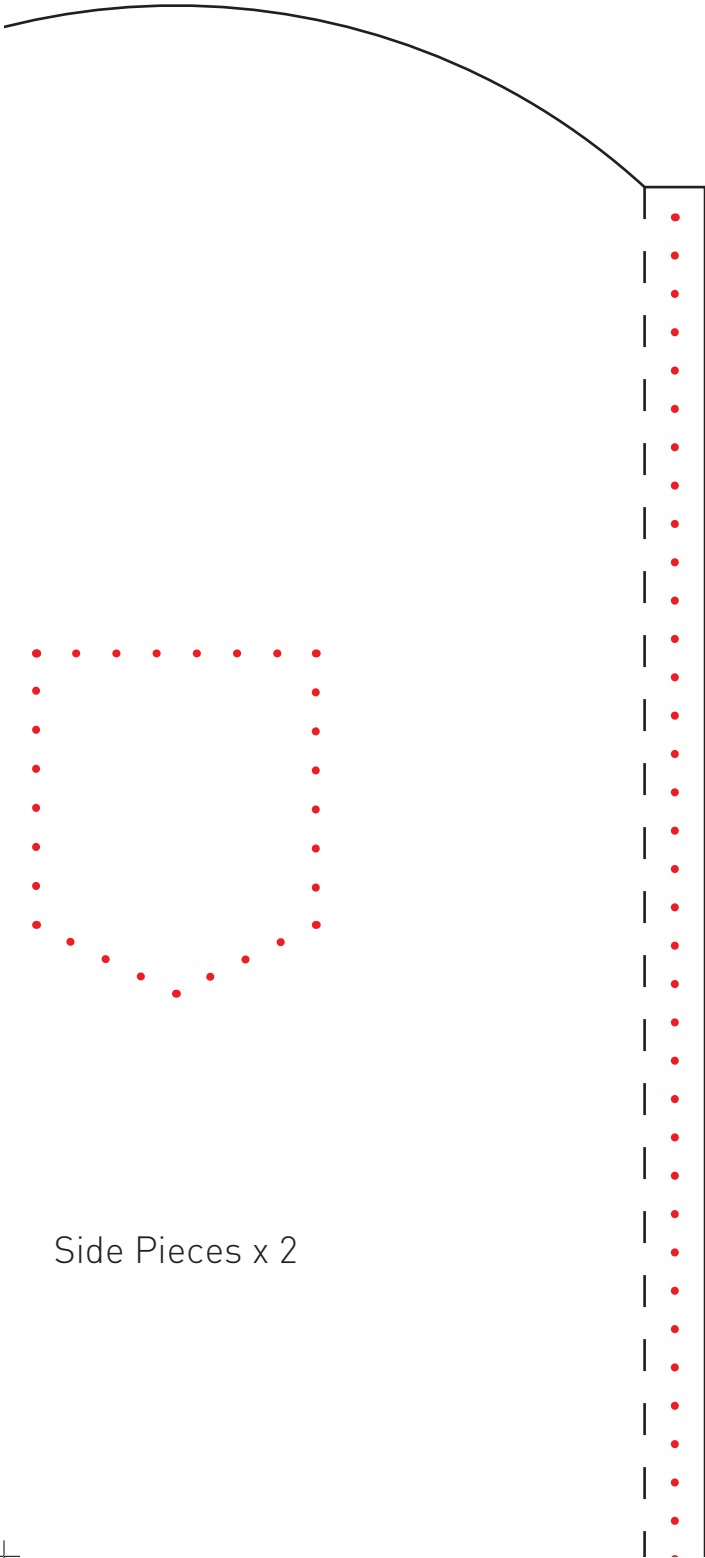

Side Pieces x 2

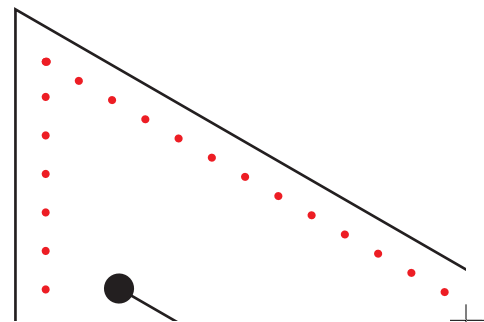
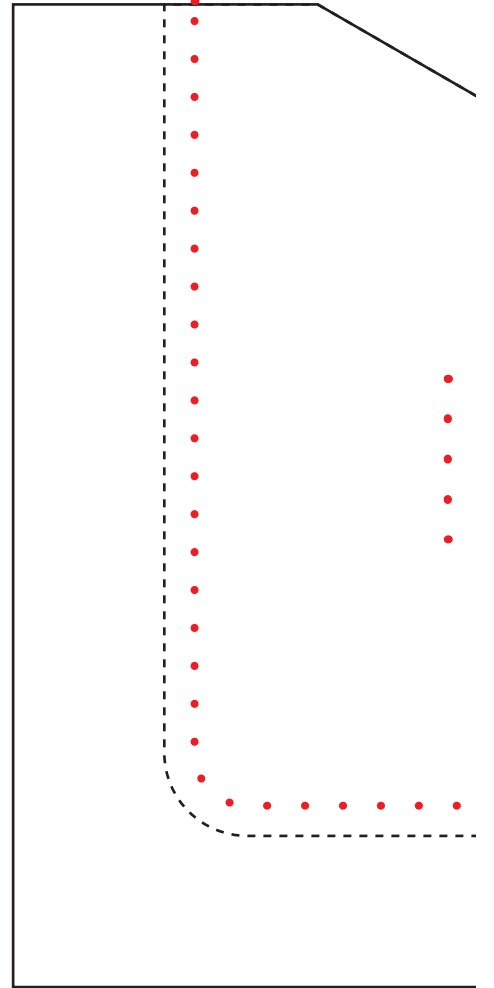

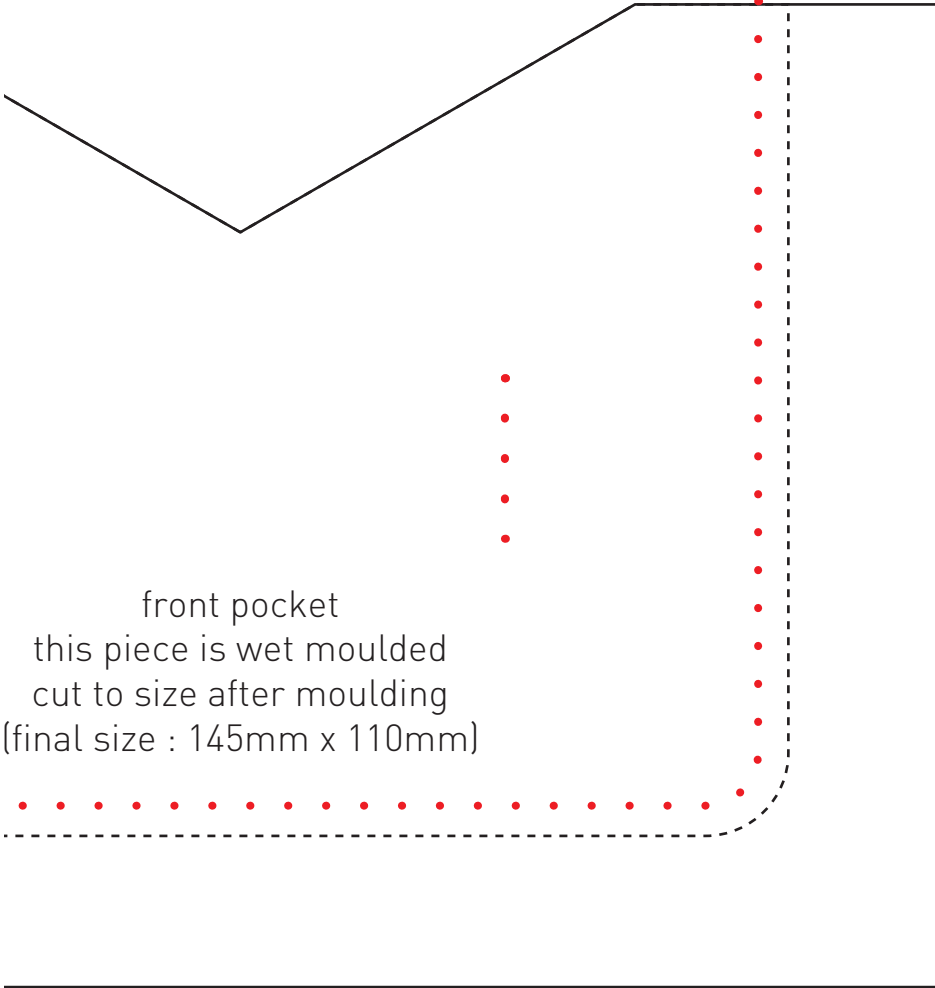

front pocket
this piece is wet moulded
cut to size after moulding
(final size : 145mm x 110mm)

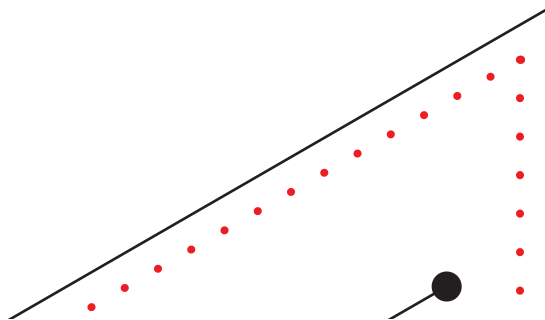
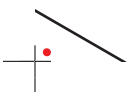

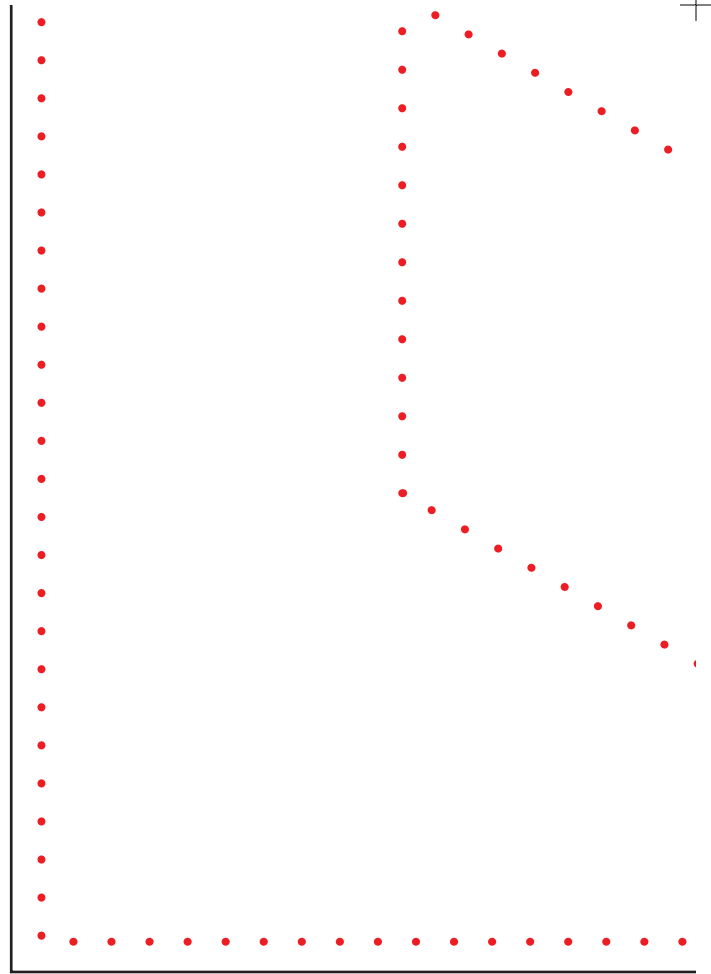

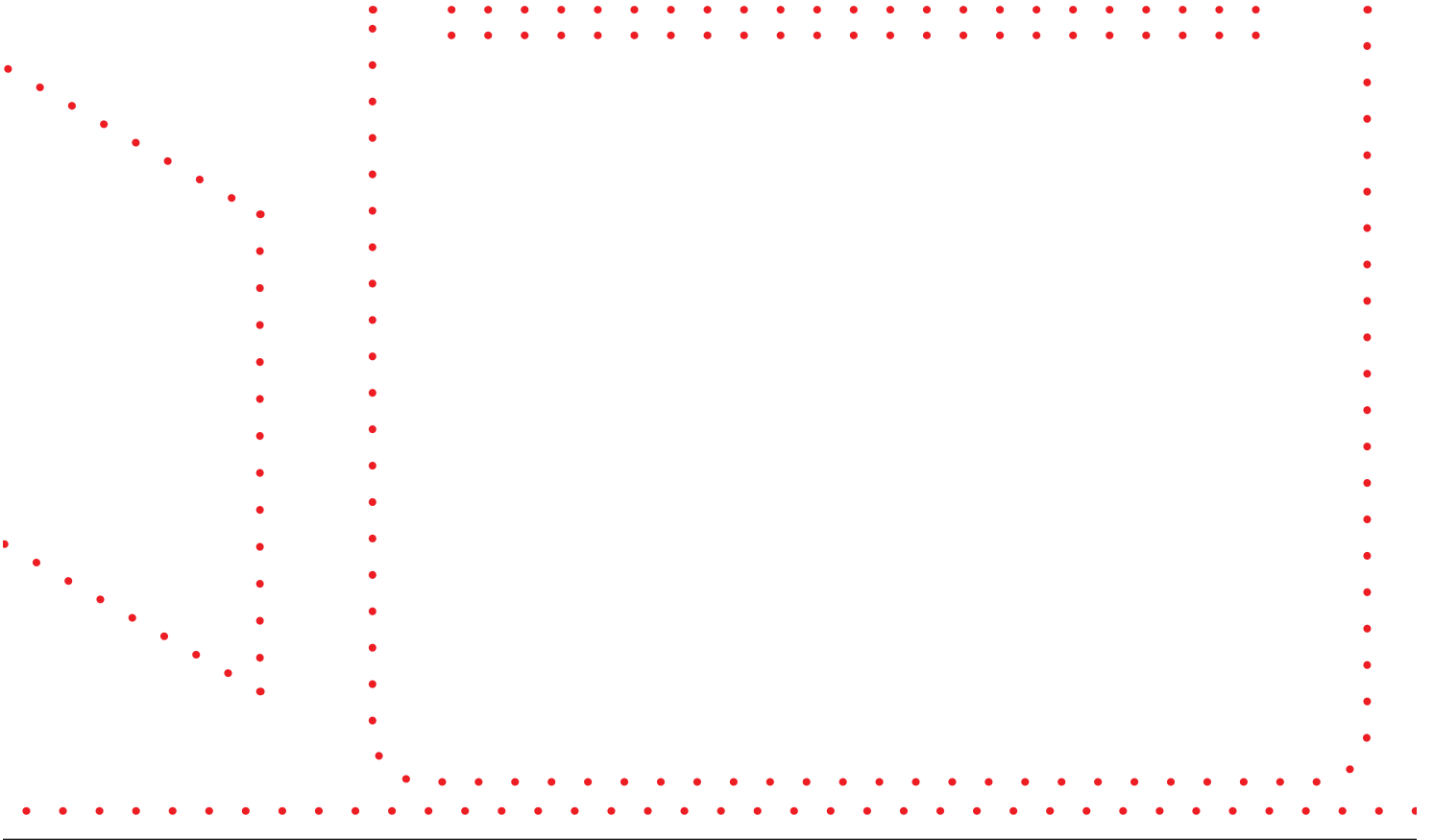

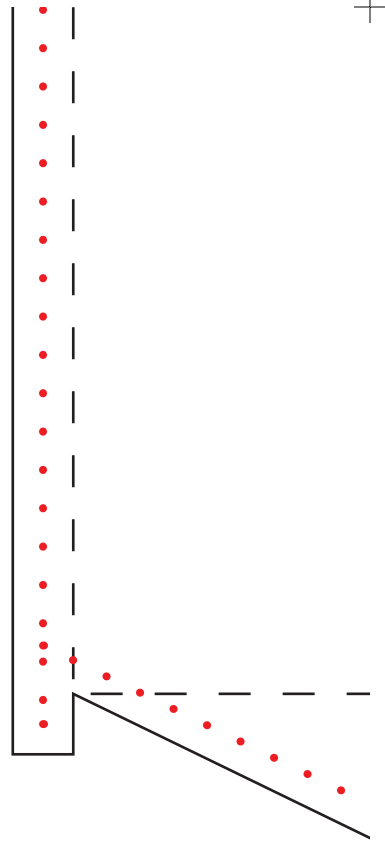
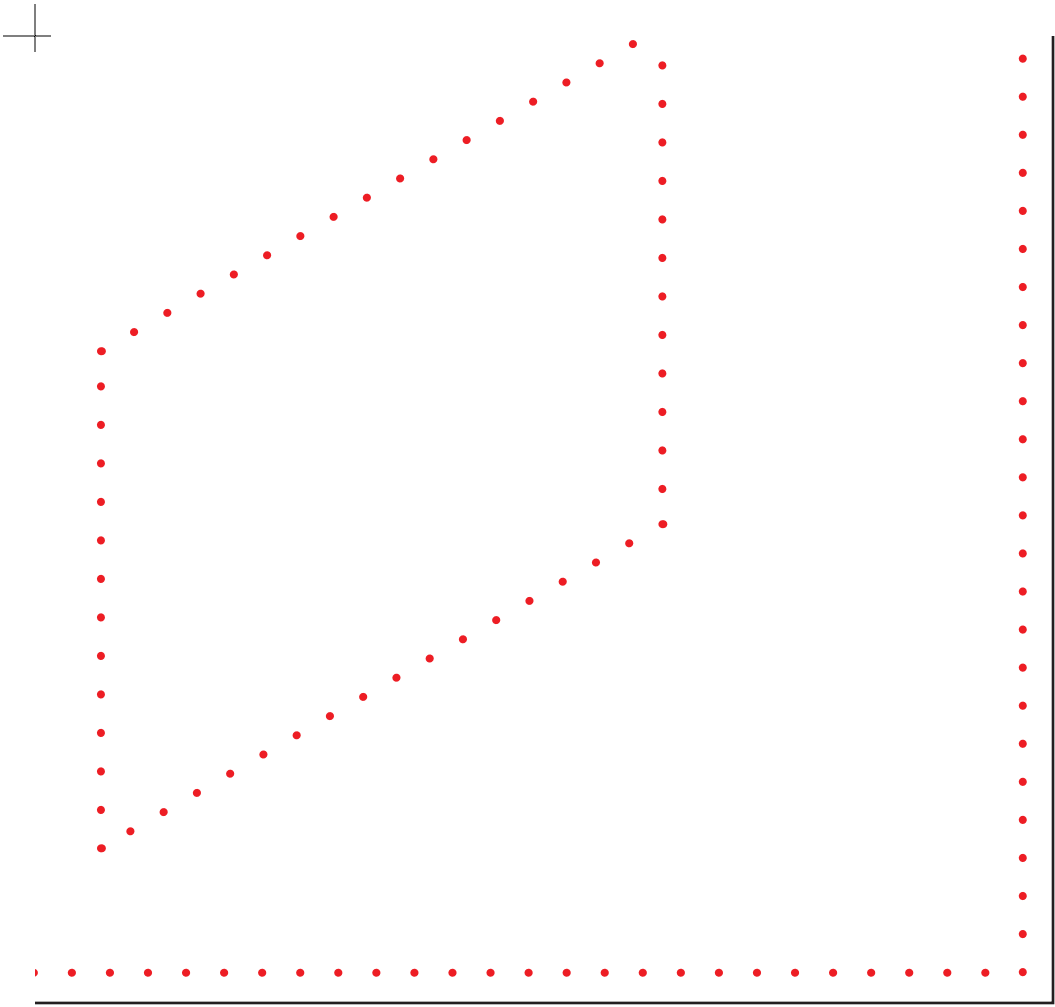

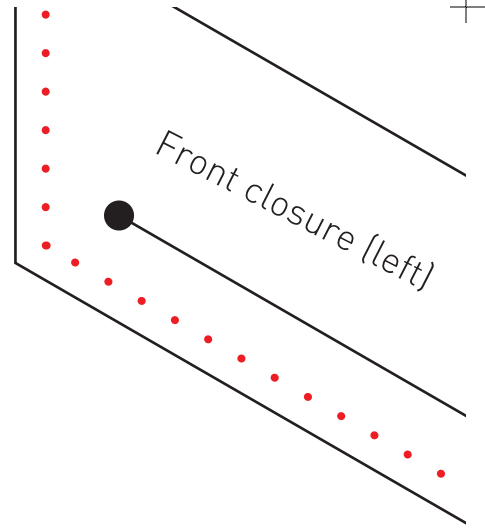
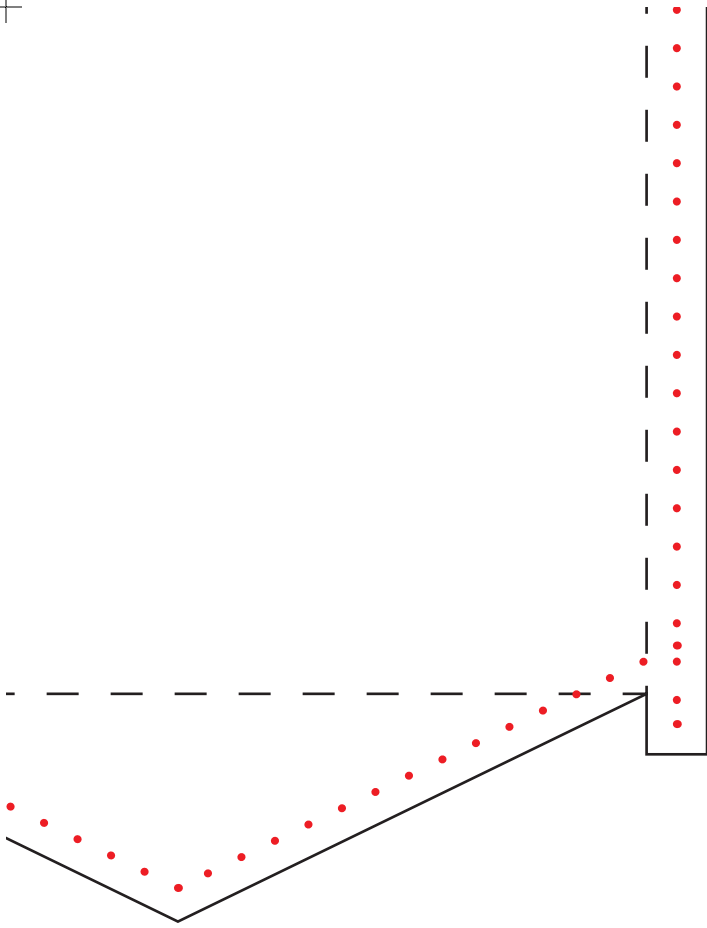

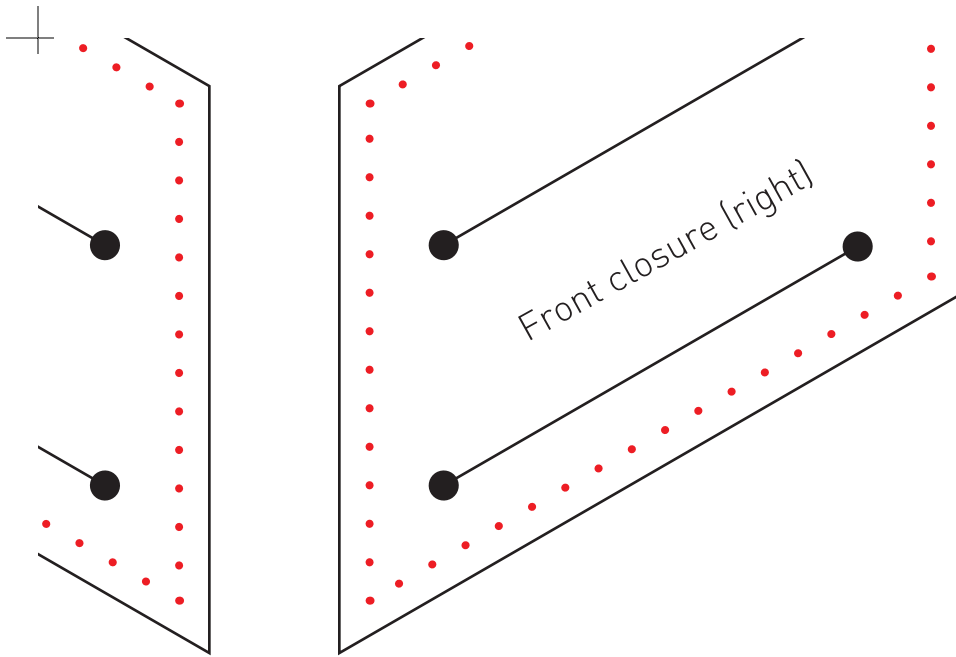

Leather Laptop Bag

A leather bag with no hardware

www.highonglue.com







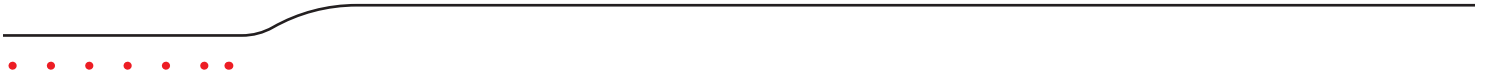

⊥

⊥

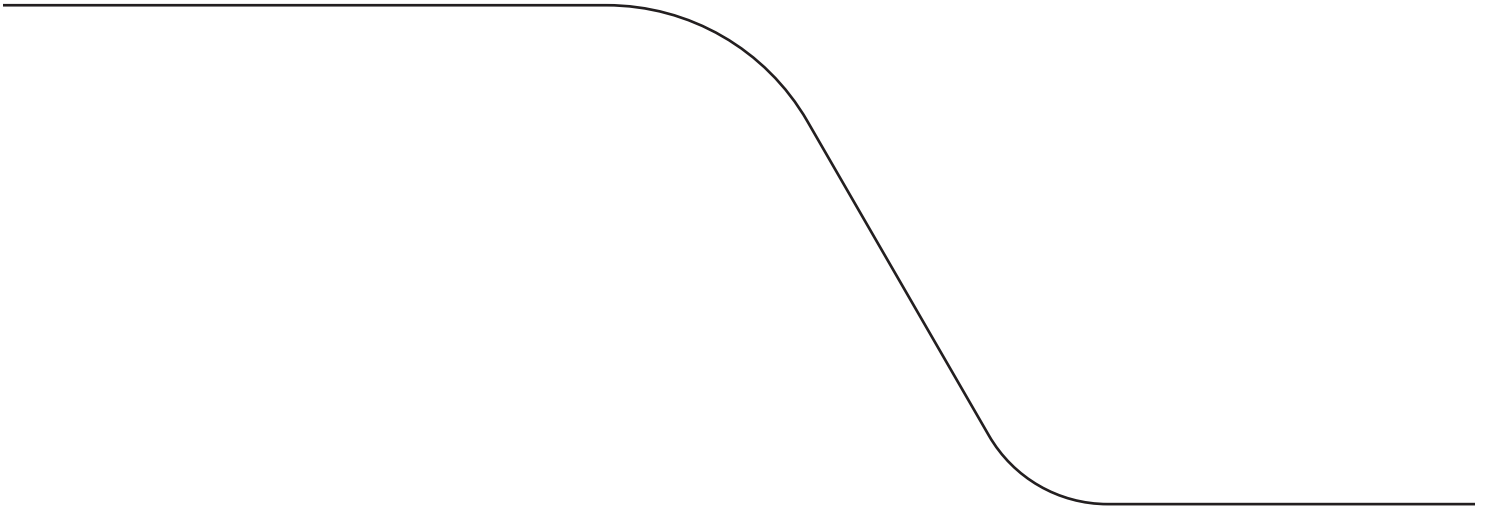

+

+

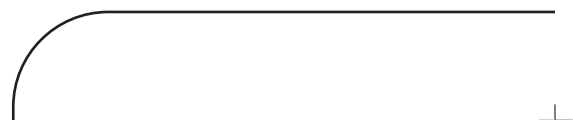

⊥

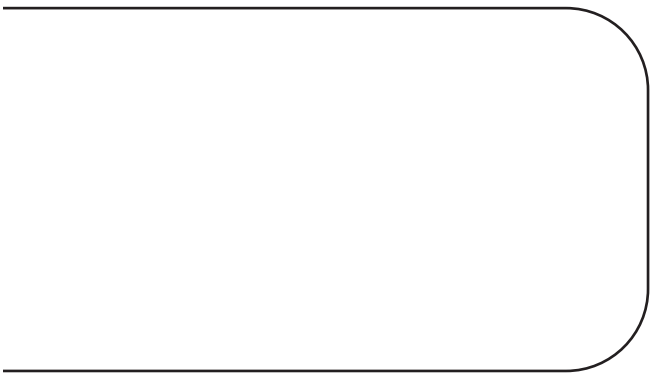

+

⊥







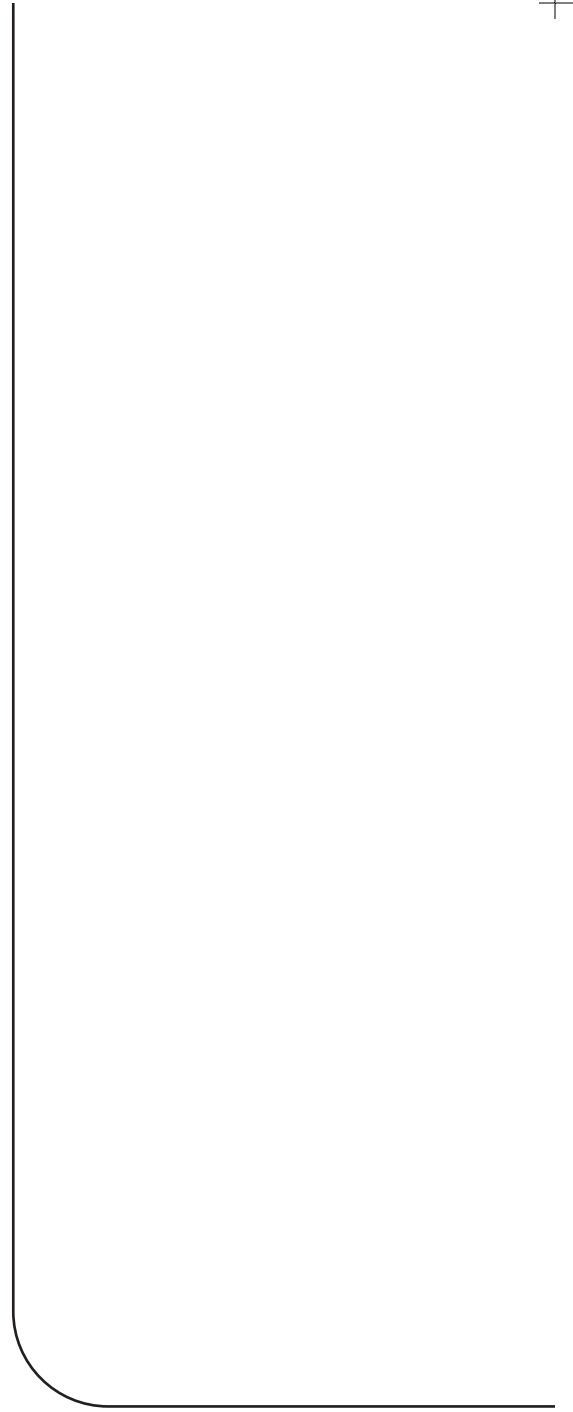

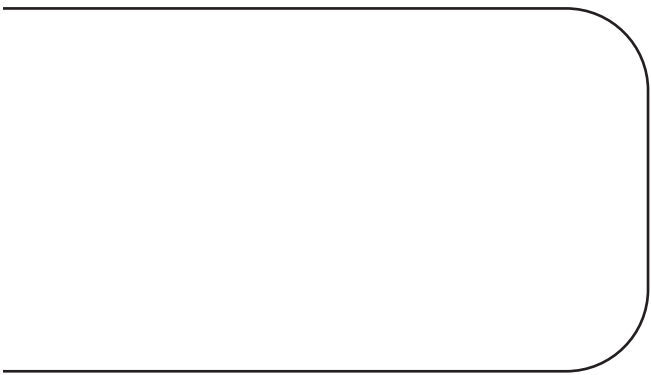

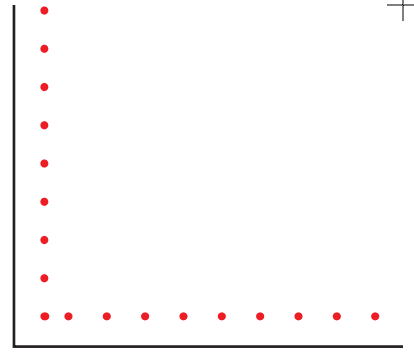





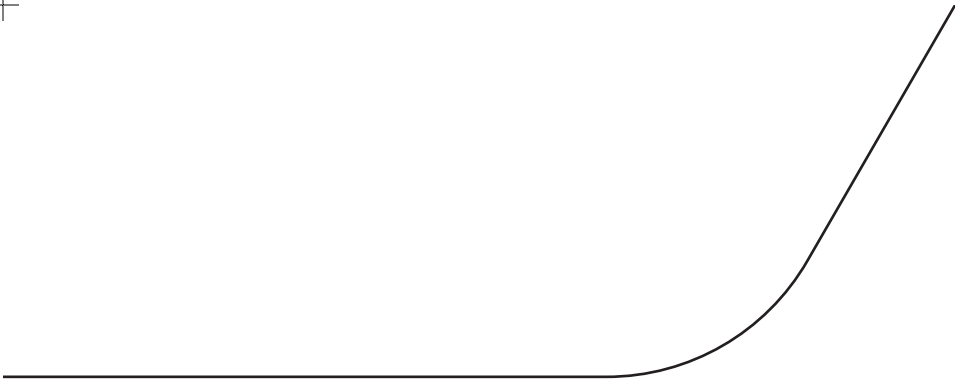

Leather Laptop Bag

A leather bag with no hardware

www.highonglue.com

